

## INTRODUCTION TO CLARITY LOGIC

ClarityLogic is the name of our simplified and easy to use customer support service. While talking to a Clarity representative, the telephone sends information such as its model name and settings to Clarity. The representative is immediately aware of the type and current settings of the phone. This will allow any troubleshooting call to be quick and simple, helping you and exactly what you are looking for.

## ClarityLogic® Memory Dial

For your convenience, Clarity has pre-programmed the customer support number into M1 of the phone. If you do not wish to have this number stored in your phone, any new number can be programmed to that button. To do this, follow the directions in the MEMORY STORAGE section of the User Guide.

**NOTE:** ClarityLogic has been designed to work with plain old telephony service (POTS). If your phone service is provided by a broadband service provider, ClarityLogic may not work. **ONLY CLARITY LOGIC MAY BE DISABLED. ALL OTHER FEATURES WORK AS DESCRIBED IN THIS USER GUIDE.**

## SUBSCRIPTION DATA AND PRIVACY POLICY

Your device will automatically send Clarity various types of information as part of the Clarity services, which may include the phone number associated with your device. This information may be combined with account and other information we have on record regarding you or your device or may be transmitted to us by your device. To assist with remote diagnostics and other customer services functions, your device may also regularly send us certain information associated with your device, including software and hardware settings, the phonebook, caller ID history and other information you have stored on the device. All of such information, together with other information that we have on record regarding you and your device is collectively referred to as the “Subscription Data”. We use this information to diagnose and troubleshoot any device issues as well as to provide you with the Services.

You agree that Clarity and its subsidiaries, affiliates, partners, suppliers, and agents (collectively, “Affiliates”) may collect, store, access, disclose, transmit, process, and otherwise use your Subscription Data to provide you with the Clarity services, address your requests, provide technical support, process transactions for your account, and otherwise use such Subscription Data in accordance with Clarity’s privacy policy (<http://www.clarityproducts.com/privacy.asp>), which is hereby incorporated by reference. Clarity may also provide or enable certain Services through your Device that rely upon location information. In order to provide such Services, Clarity and its Affiliates may collect, store, access, disclose, transmit, process, and otherwise use your location data (including real time geographic information) in accordance with Clarity’s privacy policy.

## TROUBLESHOOTING

No Dial Tone/Phone Will Not Operate

1. Check all phone cords and connections. Make sure they are plugged in securely.
2. Plug unit into a different phone jack to help determine if the difficulty is with the phone or the phone jack.
3. Switch out handset or telephone line cords.
4. Disconnect any other equipment that may be attached to the phone.

Unable To Dial Out

1. Make sure TONE/PULSE switch is set correctly.
2. Phone may be at the end of a long line of phones (loop). Phone may not be getting enough power from the phone line. It may be necessary to wait for a few seconds after lifting the handset to begin dialing.
3. The XL40D is not compatible with Digital PBX Systems. If a standard, single line phone works on the system, your XL40D should also.
4. There is an advanced computer running inside the XL40D. Sometimes after the handset is picked up, it will take a little less than a second to engage the phone. Since it is not immediate, if you dial a number before the computer engages, it will not receive the entire phone number that is dialed.

The Operate On The Other End Cannot Hear You

1. Too many phones or phone devices on the line may effect your phone’s transmission. As a guideline, more than five (5) phones or phone devices may overload the phone line. Disconnect one (1) or two (2) devices to see if that eliminates the problem. If not, contact your local phone company for load guidelines.
2. You may not be speaking directly into the transmitter. Always speak directly into the mouth piece in your normal tone of voice.

Unable To Hear Phone Ringer

1. Too many phone or phone devices on a line may cause your phone to not ring. Disconnect one (1) or two (2) of the devices to see if the problem is eliminated. If not, contact your local phone company for load guide lines.
2. If power is not being supplied to the phone, the extra loud ringer, will not work.
3. Check the Ringer ON/OFF switch to see if the ringer is off.

Volume Control Does Not Work

1. BOOST must be activated to turn on the additional amplification.
2. Check power connections. BOOST will not work without power or backup batteries.

Unable to Access Automated Systems

Automated systems used by banks, long distance voice mail and other applications require that a phone be set to “TONE” dialing. Check the switch on the bottom of the phone labeled TONE/PULSE and set to TONE. This will enable the phone to be compatible with these automated systems.

If the power goes out, or the AC Adapter is not properly connected to the phone, the amplification, extra loud ringer, and the lighted keypad will not work. If you have backup batteries installed, amplification will still work, but the phone will drain the backup batteries very quickly. This will cause the need for the batteries to be changed frequently and the Low Battery indicator light to constantly illuminate.

**Do I Need to Install Batteries?** Batteries are optional. They provide backup in case of a power outage. They are recommended in areas of frequent power outages. This phone uses four (4) alkaline batteries. When installed and fully charged, the batteries maintain the high amplification for your telephone.

## IMPORTANT SAFETY INSTRUCTIONS

When using your telephone equipment, basic safety precautions should always be followed to reduce the risk of fire, electric shock and injury to persons including the following:

1. Read and understand all instructions.
2. Follow all warnings and instructions marked on the telephone.
3. Do not use this telephone near a bathtub, wash basin, kitchen sink or laundry tub, in a wet basement, near a swimming pool or any where else there is water.
4. Avoid using a telephone (other than a cordless type) during a storm. There may be a remote risk of electrical shock from lightning.
5. Do not use the telephone to report a gas leak in the vicinity of the leak.
6. Unplug this telephone from the wall outlets before cleaning. Do not use liquid cleaners or aerosol cleaners on the telephone. Use a damp cloth for cleaning.
7. Place this telephone on a stable surface. Serious damage and/or injury may result if the telephone falls.
8. Do not cover the slots and openings on this telephone. This telephone should never be placed near or over a radiator or heat register. This telephone should not be placed in a built-in installation unless proper ventilation is provided.
9. Operate this telephone using the electrical voltage as stated on the base unit or the owner’s manual. If you are not sure of the voltage in your home, consult your dealer or local power company.
10. Do not place anything on the power cord. Install the telephone where no one will step or trip on the cord.
  1. Do not overload wall outlets or extension cords as this can increase the risk of fire or electrical shock.
  2. Never push any objects through the slots in the telephone. They can touch dangerous voltage points or short out parts that could result in a risk of fire or electrical shock. Never spill liquid of any kind on the telephone.
  3. To reduce the risk of electrical shock, do not take this phone apart. Opening or removing covers may expose you to dangerous voltages or other risks. Incorrect reassembly can cause electric shock when the appliance is subsequently used.
  4. Unplug this product from the wall outlet and refer servicing to the manufacturer under the following conditions: when the power supply cord or plug is frayed or damaged; if liquid has been spilled into the product; if the telephone has been exposed to rain or water; if the telephone does not operate normally by following the operating instructions. adjust only those controls that are covered by the operating instructions. Improper adjustment may require extensive work by a qualified technician to restore the telephone to normal operation; if the telephone has been dropped or the case has been damaged; if the telephone exhibits a distinct change in performance.
  5. Never install telephone wiring during a lightning storm.
  6. Never install telephone jacks in wet locations unless the jack is specifically designed for wet locations.
  7. Never touch uninsulated telephone wires or terminals unless the telephone line has been disconnected at the network interface.
  8. Use caution when installing or modifying telephone lines.

## BATTERY SAFETY INFORMATION

Dispose of used batteries according to the instructions.

1. Do not dispose of the battery in a fire as it may explode. Check with local codes for possible special disposal instructions.
2. Do not open or mutilate the battery. Released electrolyte is corrosive and may cause damage to the eyes and skin. It may be toxic if swallowed.
3. Exercise care in handling batteries in order not to short the battery with conducting materials such as rings, bracelets and keys. The battery or conduction material may overheat and cause burns.

## REGULATORY COMPLIANCE

Part 68 of FCC Rules Information

a) This equipment complies with Part 68 of the FCC rules and the requirements adopted by the ACTA. On the bottom of this equipment is a label that contains, among other information, a product identifier in the format US:AAAEQ##TXXXX. If requested, this number must be provided to the telephone company.

b) A plug and jack used to connect this equipment to the premises wiring and telephone network must comply with the applicable FCC Part 68 rules and requirements adopted by the ACTA. A compliant telephone cord and modular plug, RJ11 IC USOC, is provided with this product. It is designed to be connected to a compatible modular jack that is also compliant. See installation instructions for details.

c) The REN is used to determine the number of devices that may be connected to a telephone line. Excessive RENs on a telephone line may result in the devices not ringing in response to an incoming call. In most but not all areas, the sum of RENs should not exceed five (5.0). To be certain of the number of devices that may be connected to a line, as determined by the total RENs, contact the local telephone company. For products approved after July 23, 2001, the REN for this product is part of the product identifier that has the format US:AAAEQ##TXXXX.

The digits represented by ## are the REN without a decimal point (e.g., 03 is a REN of 0.3). For earlier products, the REN is separately shown on the label.

d) If this telephone equipment causes harm to the telephone network, the telephone company will notify you in advance that temporary discontinuance of service may be required. But if advance notice isn’t practical, the telephone company will notify the customer as soon as possible. Also, you will be advised of your right to file a complaint with the FCC if you believe it is necessary.

e) The telephone company may make changes in its facilities, equipment, operations or procedures that could affect the operation of the equipment. If this happens the telephone company will provide advance notice in order for you to make necessary modifications to maintain uninterrupted service.

f) If trouble is experienced with this telephone equipment, for repair or warranty information, please contact Clarity, 1-800-552-3368. If the equipment is causing harm to the telephone network, the telephone company may request that you disconnect the equipment until the problem is resolved.

g) This telephone equipment is not intended to be repaired and it contains no repairable parts. Opening the equipment or any attempt to perform repairs will void the warranty. For service or repairs, call 1-800-552-3368.

h) Connection to party line service is subject to state tariffs. Contact the state public utility commission, public service commission or corporation commission for information.

i) If your home has specially wired alarm equipment connected to the telephone line, ensure the installation of this telephone equipment does not disable your alarm equipment. If you have questions about what will disable alarm equipment, consult your telephone company or a qualified installer.

j) This telephone equipment is hearing aid compatible.

Customer-Owned Coin/Credit Card Phones:

To comply with state tariffs, the telephone company must be given notification prior to connection. In some states, the state public utility commission, public service commission or corporation commission must give prior approval of connection.

## REGULATORY COMPLIANCE

Part 15 of FCC Rules Information

This device complies with Part 15 of the FCC Rules. Operation is subject to the following two conditions: (1) This device may not cause harmful interference, and (2) this device must accept any interference received, including interference that may cause undesired operation.

Your equipment has been tested and found to comply with the limits of a Class B digital device, pursuant to Part 15 of FCC rules. These limits are designed to provide reasonable protection against harmful interference in residential installation.

This equipment generates, uses and can radiate radio frequency energy and, if not installed and used in accordance with the instructions, may cause harmful interference to radio communications. However, there is no guarantee that interference will not occur in a particular installation; if this equipment does cause harmful interference to radio or television reception, which can be determined by turning the equipment off and on, you are encouraged to try to correct the interference by one of the following measures:

1. Where it can be done safely, reorient the receiving television or radio antenna.
2. To the extent possible, relocate the television, radio or other receiver with respect to the telephone equipment. (This increases the separation between the telephone equipment and the receiver.)
3. Connect the telephone equipment into an outlet on a circuit different from that to which the television, radio, or other receiver is connected.
4. Consult the dealer or an experienced Radio/TV Technician for help.

**CAUTION:** Changes or modifications not expressly approved by the manufacturer responsible for compliance could void the user’s authority to operate the equipment.

Industry Canada Technical Specifications

This product meets the applicable Industry Canada technical specifications.

Before installing this equipment, users should ensure that it is permissible to be connected to the facilities of the local telecommunications company. The equipment must also be installed using an acceptable method of connection. In some cases, the company’s inside wiring associated with a single line individual service may be extended by means of a certified connector assembly (telephone extension cord). The customer should be aware that compliance with the above conditions may not prevent degradation of service in some situations. Repairs to certified equipment should be made by an authorized Canadian maintenance facility designated by the supplier. Any repairs or alterations made by the user to this equipment, or equipment malfunctions, may give the telecommunications company cause to request the user to disconnect the equipment. Users should ensure for their own protection that the electrical ground connections of the power utility, tele-phone lines and internal metallic water pipe system, if present, are connected together. This precaution may be particularly important in rural areas.

**CAUTION:** Users should not attempt to make such connections themselves, but should contact the appropriate electrical inspection authority, or electrician, as appropriate.

The Ringer Equivalence Number is an indication of the maximum number of terminals allowed to be connected to a telephone interface. The termination on an interface may consist of any combination of devices subject only to the requirement that the sum of the Ringer Equivalence Numbers of all the devices does not exceed five.

(The term “IC:” before the certification/registration number only signifies that the Industry Canada technical specifications were met.)

## WARRANTY SERVICE INFORMATION

The following warranty and service information applies only to products purchased and used in the U.S. and Canada. For warranty information in other countries, please contact your local retailer or distributor.  
**Limited Warranty:** Clarity, a division of Plantronics, Inc. (“Clarity”) warrants to the original consumer purchaser that, except for limitations and exclusions set forth below, this product shall be free from defects in materials and workmanship for a period of one (1) year from the date of original purchase (“Warranty Period”). The obligation of Clarity under this warranty shall be at Clarity’s option, without charge, of any part or unit that proves to be defective in material or workmanship during the Warranty Period.

**Exclusions from Warranty:** This warranty applies only to defects in factory materials and factory workmanship. Any condition caused by accident, abuse, misuse or improper operation, violation of instructions furnished by Clarity, destruction or alteration, improper electrical voltages or currents, or repair or maintenance attempted by anyone other than Clarity or an authorized service center, is not a defect covered by this warranty. Telephone companies manufacture different types of equipment and Clarity does not warrant that its equipment is compatible with the equipment of a particular phone company.

**Implied Warranties:** Under state law, you may be entitled to the benefit of certain implied warranties. These implied warranties will continue in force only during the warranty period. Some states do allow limitations on how long an implied warranty lasts, so the above limitation may not apply to you.

**Incidental or Consequential Damages:** Neither Clarity nor your retail dealer or selling distributors has any responsibility for any incidental or consequential damages including without limitation, commercial loss or profit, or for any incidental expenses, expenses, loss of time, or inconvenience. Some states do not allow exclusion or limitation of incidental or consequential damage, so the above limitation or exclusion may not apply to you.

Please use the original container, or pack the unit(s) in a sturdy carton with sufficient packing material to prevent damage. Include the following information:

- A proof-of-purchase indicating model number and date of purchase;
- Bill-to address;
- Ship-to address.;
- Number and description of units shipped;
- Name and telephone number of person to call, should contact be necessary.;
- Reason for return and description. of the problem.

Damage occurring during shipment is deemed the responsibility of the carrier, and claims should be made directly with the carrier.



Discount Therapy, Fitness, Pain Relief & Medical Equipment

SCOTTSDALE 480-767-6800 • 1-800-377-8033 • PEORIA 623-215-8470



# XL40D™

Amplified Telephone with DCP™

www.ActiveForever.com

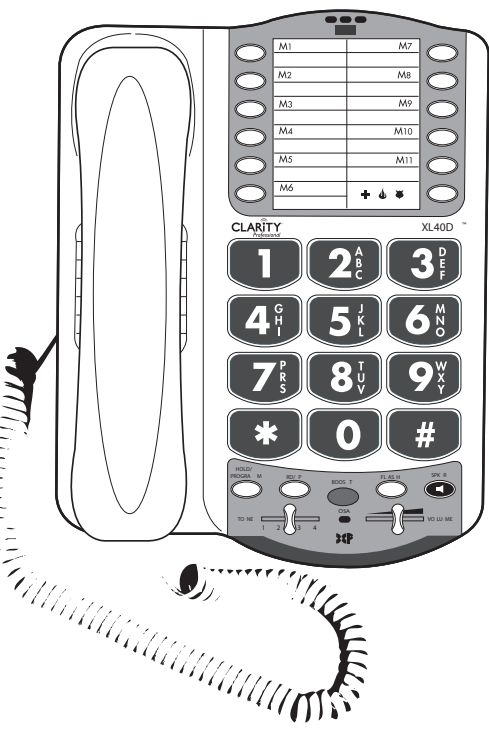

## SECTION 1 INSTALLING YOUR XL40D

Install the backup batteries (optional) by removing the battery cover as shown in Figure 1. Connect your telephone as shown in Figure 2.

- 1 Connect one end of the phone cord into the (square) LINE port on the back of the phone; connect the other end of the phone cord into your wall telephone outlet.
- 2 Connect one end of the (curly) handset cord into the handset jack on the left side of your base; connect the other end of the handset cord into the bottom of the handset. Place handset in cradle.
- 3 Connect the DC adapter cord into the (round) DC 9V 500mA port on the back of your phone; plug the adapter into your wall electrical outlet. When finished, lift handset to test. If you hear a dial tone, your telephone is ready for use. If not, check all connections again.

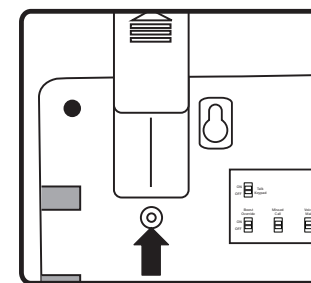

Figure 1

Remove battery cover using a thin object (like the tip of a pen) to push down the tab shown by the arrow above.

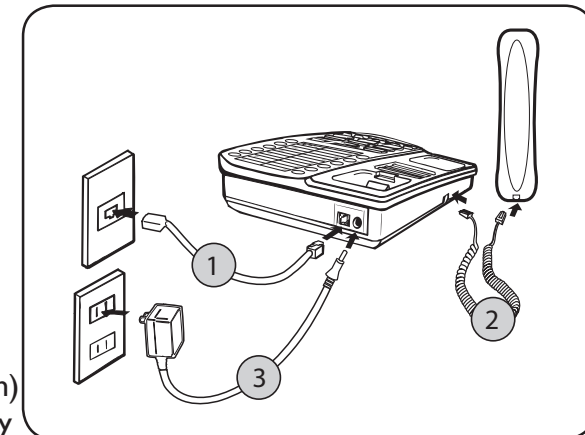

Figure 2

If there is a power outage, the XL40D will maintain its full amplification for up to 48 hours with four AA alkaline backup batteries (not included).

The phone operates as a regular phone if there is no power or backup batteries. In this case, the indicator lights, the loud ringer, the lighted keypad and the amplification will be disabled; you will still be able to make and receive phone calls, but the extra amplification will not be engaged. We recommend installing batteries if you live in an area with frequent power outages.

## SECTION 2 WALL MOUNTING YOUR XL40D

1. Pull the handset hook out of the base and reverse its position so that the hook points up and will hold the handset when you hang up. See Figure 3
2. Plug one end of the short telephone line cord into the jack marked LINE located on the back of the telephone. Then run the cord through the groove on the back of the phone. Insert the tabs of the mounting bracket into the slots in the back of the phone. Push the mounting bracket in and down firmly until it snaps into place. See Figure 4.
3. Plug the telephone line cord into the wall plate jack, then align the mounting bracket's keyhole slots with the wall plate studs and slide the base of the phone downward to secure it on the wall. See Figure 5.

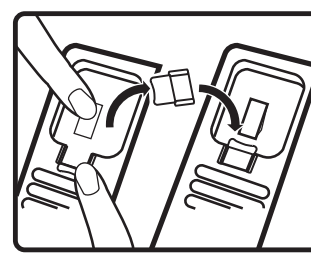

Figure 3

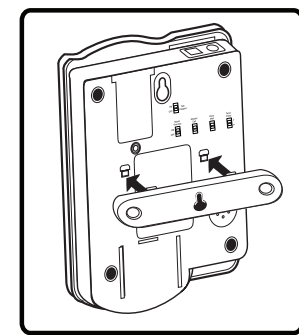

Figure 4

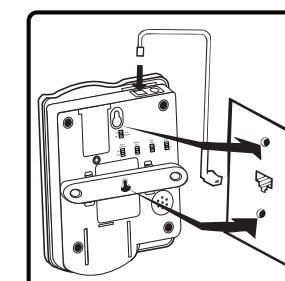
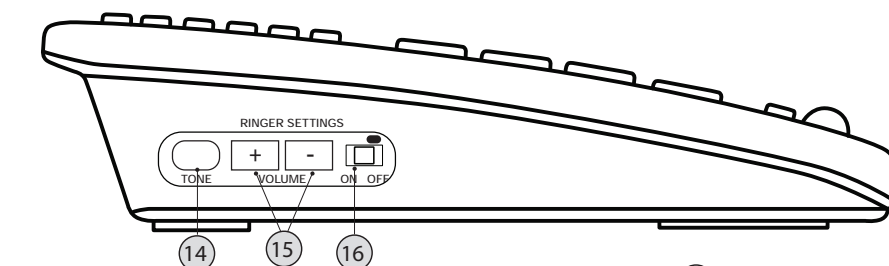
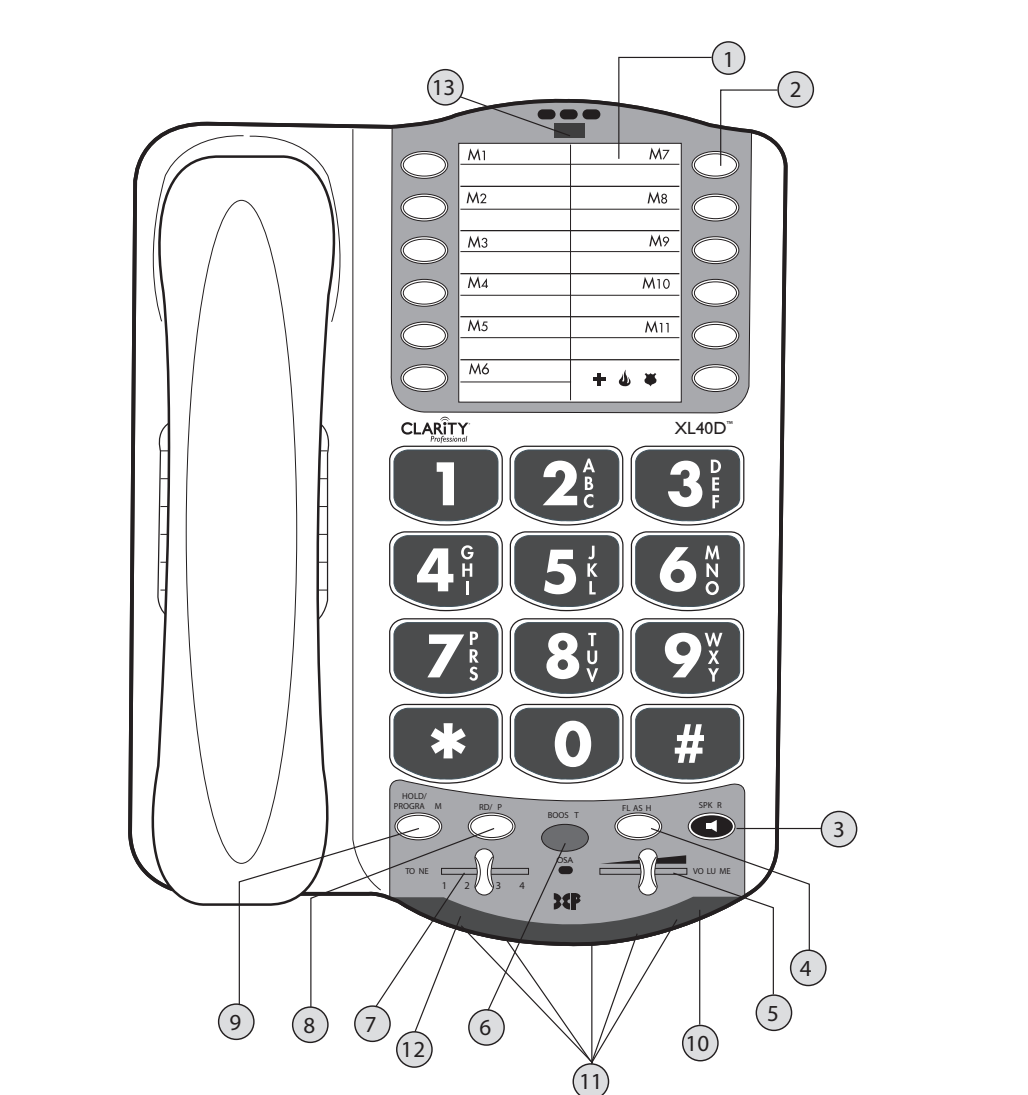
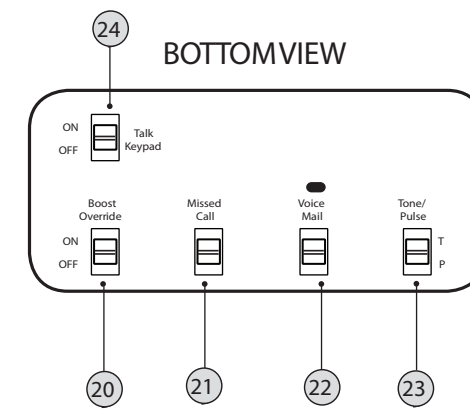
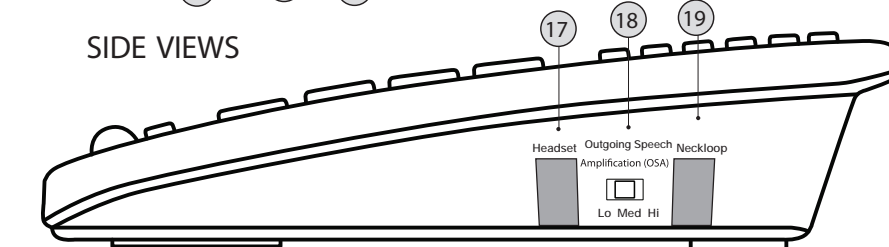

Figure 5

## SECTION 3 FEATURE LIST AND OVERVIEW



SIDE VIEWS



BOTTOMVIEW

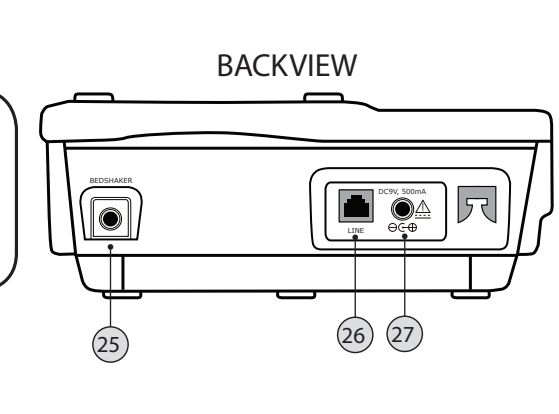

BACKVIEW

## SECTION 4 FEATURE LIST AND OVERVIEW

- 1 Phone Number Directory : use this area to write down the names of the saved memory records. Remove transparent plastic cover to reach the blank list.
- 2 Memory Buttons (M1-M11 and Emergency): for saved numbers (see MEMORY STORAGE section for details).
- 3 SPKR (Speaker) Button: press SPKR to engage the speakerphone function; press again to turn the feature off.
- 4 FLASH Button: use this button to engage the Call Waiting Caller ID functions (feature provided by local phone company).
- 5 VOLUME Slider: move to right or left in order to increase or decrease the volume of the incoming voice.
- 6 BOOST/OSA Button: press BOOST to engage the extra amplification. In BOOST OFF mode, the phone has a volume range of up to 16dB of amplification. In BOOST ON mode, the phone has a volume range of up to 50dB of amplification. When active, the BOOST button is backlit. Press BOOST again to turn off the extra amplification. Press and hold the button for 3 seconds to engage the OSA function (to enhance the level of your voice). See OSA section for details. NOTE: when OSA is enabled, the light at the top of the phone turns orange when the phone is in a call.
- 7 TONE Switch: use this switch to pick one of the 4 tone setting available.
- 8 RD/P (Redial/Pause) Button: use this button to redial the last number dialed (up to 32 digits). When in programming mode, press this button to insert a 2-second pause.
- 9 HOLD/PROGRAM Button: during a call, use this button to put the call on hold; press the button again to release the call from hold. Use this button to program the memory keys during idle state or during a call. (see MEMORY STORAGE section for details).
- 10 Low Battery Indicator: light turns on when the backup batteries are low.
- 11 Visual Ringer Lights: lights turn on and off when the phone rings.
- 12 Missed Call light: light turns on when there was an unanswered call. (Active when Missed Call switch is ON - located on bottom of phone).
- 13 Voice Mail/Ringer/OSA light: a. Light turns on GREEN when there is a voicemail left with your voicemail feature (from local phone company). b. Light turns RED when the ringer switch is in the OFF position. c. Light turns ORANGE when the OSA feature is active.
- 14 Ringer/TONE : press this button to choose the desired incoming ring tonality. Choose one of the six (6) available ring tones to select the most favorable ringer.
- 15 Ringer/Volume +/- : press the keys to increase/decrease the volume of the incoming ring.
- 16 Ringer ON/OFF switch: use this switch to turn the ringer on or off. When the switch is set to OFF, the light at the top of the phone lights up RED .
- 17 Headset port: insert a standard headset (2.5mm plug) to use instead of handset.
- 18 Outgoing Speech Amplification (OSA) switch : use the switch to set the level of the outgoing speech amplification level. To enable/disable the OSA switch, press and hold the BOOST/OSA button for 3 seconds (see OSA section).
- 19 Neckloop port: insert a standard neckloop (mono, 3.5mm plug) to use with your T-coil equipped hearing aid. We recommend the Clarity CE30 neckloop.
- 20 Boost Override switch: set to ON if you wish for the BOOST function to be enabled at the beginning of all calls.
- 21 Missed Call switch: set to ON if you wish to have the Missed Call light enabled.
- 22 Voice Mail switch: set to ON if you wish for the light at the top of the phone to turn GREEN when you have a voice mail (service from your phone service provider).
- 23 Tone/Pulse switch: set this switch to the desired dialing method.
- 24 Talk Keypad switch: set to ON if you wish to hear the numeric keys pressed during dialing - both in handset and speakerphone modes. NOTE: "star" and "pound" keys are not spoken.
- 25 BEDSHAKER port: insert the optional bedshaker (sold separately); it will vibrate to indicate incoming rings.
- 26 LINE: see INSTALLING YOUR XL40D section.
- 27 POWER PORT (9V,500mA): see INSTALLING YOUR XL40D section.

## SECTION 5 BOOST FUNCTION - AMPLIFY INCOMING SOUNDS

1. While on a call, press the BOOST button to engage the amplifier. The XL40D has a BOOST button that controls the loudness of the receiver. See Figure 6. Once the BOOST button is pressed, an extra level of amplification is added over the entire range of the Volume Control. During a call, the BOOST button can toggle the Clarity Power function on or off according to the user's needs. The BOOST button will reset automatically every time the phone is hung up for at least 5 seconds. The BOOST light will illuminate (blue) while the BOOST function is activated.

Warning: Volume may be at a high level. To protect hearing, lower the Clarity Power/Volume Control before using the phone.

2. Adjust the VOLUME slider to achieve the desired sound level (up to 50dB of amplification). The Clarity Power/Volume Control adjusts the level of volume of the handset both in Boost or non-Boost modes. The volume dial provides up to 16dB of volume before the BOOST button is activated. Once the BOOST button is pressed, the XL40D will provide up to 50dB of gain. See Figure 7.

3. Adjusting the TONE switch allows you to customize your hearing experience. Since we all have different hearing preferences we suggest exploring each setting to find the one most comfortable for you. These four settings, along with our volume amplification, are part of the Digital Clarity Power (DCP™) technology. See Figure 8. The available settings are:

- 1- Low Frequency emphasis: best used to hear low pitched sounds;
- 2 - Flat frequency response: best for hearing aid users;
- 3 - Clarity Power/High frequency emphasis response: best used to hear high frequency sounds;
- 4 - Multi Band Compression with high frequency emphasis response: best setting for speech intelligibility.

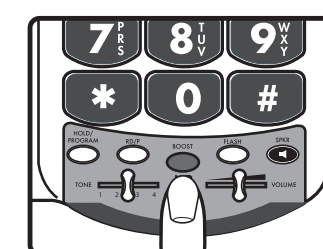

Figure 6

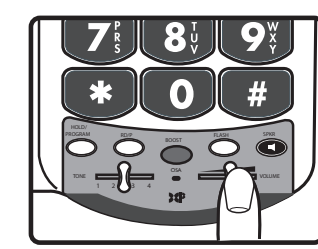

Figure 7

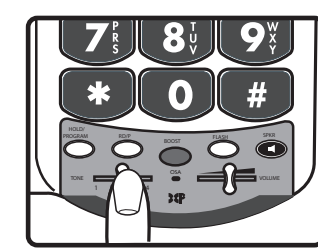

Figure 8

### Boost Override

On the bottom of the XL40D, there is a Boost Override switch. When this is set to "ON" the Boost function is automatically enabled every time the phone is picked up. In standard use, when the Boost Override switch is set to "OFF" the Boost function will turn off after the phone is hung up. Setting this switch to "ON" is suggested if all the users of the phone need the amplification. Setting this switch to "OFF" is useful when people with varying hearing ability use the phone. See Figure 9.

CAUTION: VOLUME MAY BE LOUD. PROCEED WITH CARE.

Figure 9

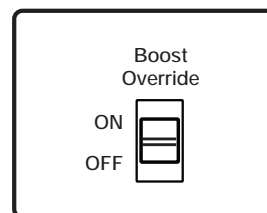

## SECTION 6 MEMORY STORAGE

1. Press and hold the desired memory location (M1-M11 and Emergency) to store the number to. The phone will beep to confirm you are in memory programming mode. See Figure 10.
2. Enter the telephone number you wish to store (up to 31 digits). If no button is pressed within 30 seconds, the phone will time out and goes back to idle or talk mode.
3. Press the Hold/Program button to save the desired number. The phone will beep to confirm the number has been saved. See Figure 11.
4. To change a Memory location, reprogram using the same procedure with the button to be changed.

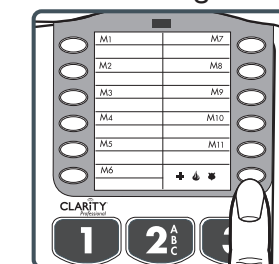

Figure 10

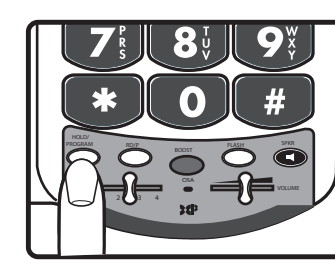

Figure 11

To dial the saved numbers:

1. In handset mode, lift the handset and press the appropriate memory button.
2. In speakerphone mode, press the appropriate memory button with the handset in the cradle.

## SECTION 7 OUTGOING SPEECH AMPLIFICATION (OSA)

This function amplifies your speech so it becomes louder to the person on the other end of the call. To enable this function, press and hold the BOOST/OSA button for 3 seconds (see Figure 12). The phone beeps; the function can be enabled/disabled while on a phone call or in standby mode. To verify the function is active, lift the handset and check the light at the top of the phone. If the light is ORANGE, the function is active. To adjust the level of amplification for your voice, use the switch on the side of the phone labeled Outgoing Speech Amplification (OSA). You can choose between three levels: Low, Med and High (see Figure 13).

To return to the default setting for your voice volume level, press and hold the BOOST/OSA button again for 3 seconds. You will hear a beep confirming that the function is disabled. To verify, the light at the top of the phone should not be orange when you are on a phone call.

NOTE: In order to experience the best audio quality for both parties during a call, we recommend you turn on this function only if your voice is too quiet. OSA is not active in speakerphone mode.

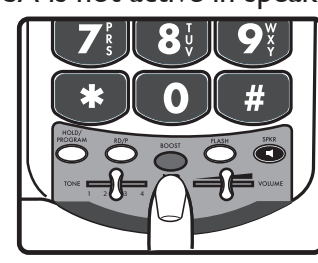

Figure 12

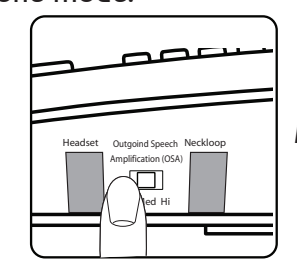

Figure 13

## SECTION 8 TECHNICAL INFORMATION

Amplified dB Level: 50dB/124 dB SPL  
 Tone control range: Full range: 300 to 3000Hz using one slide control.  
 Dimensions  
 Size: 9 1/2" x 7" x 3 1/4" (24.13cm x 17.78cm x 8.25cm)  
 Weight: 2.52 lbs. (1.14 kg)  
 Power Requirements  
 DC Adapter: 9VDC, 500 mA  
 Batteries: 4 AA alkaline batteries (not included)

## CONTENTS & PARTS CHECKLIST

Your package includes all the items as shown here. If there is anything missing, please contact our Customer Care Department immediately. NOTE: PLEASE RETAIN A COPY OF PROOF OF PURCHASE FOR YOUR RECORDS.

